

All rights reserved, Copyright Kradex 2016		
Product model	Enclosure Z106 - Assembly	
Format: A3	Material: PS, ABS	
Scale 1:1	Tolerance: +/- 0.5	

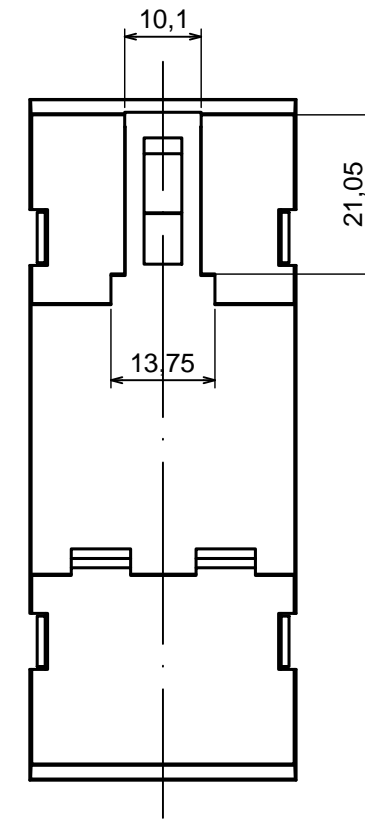
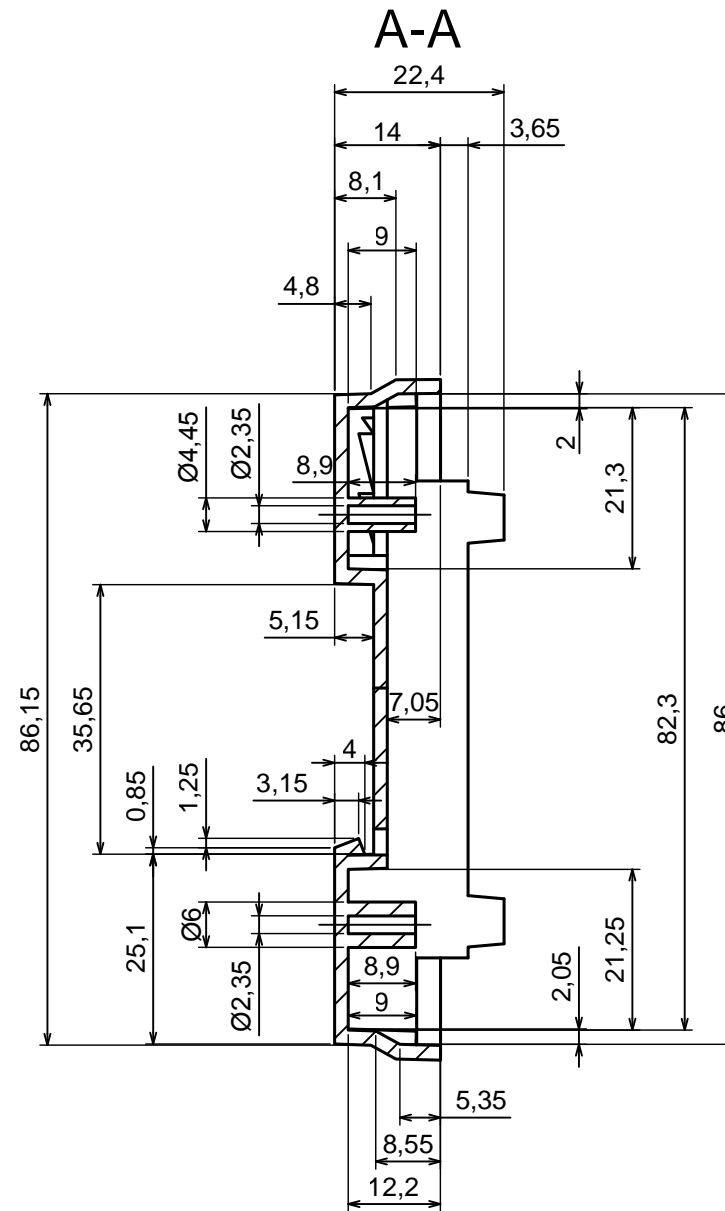
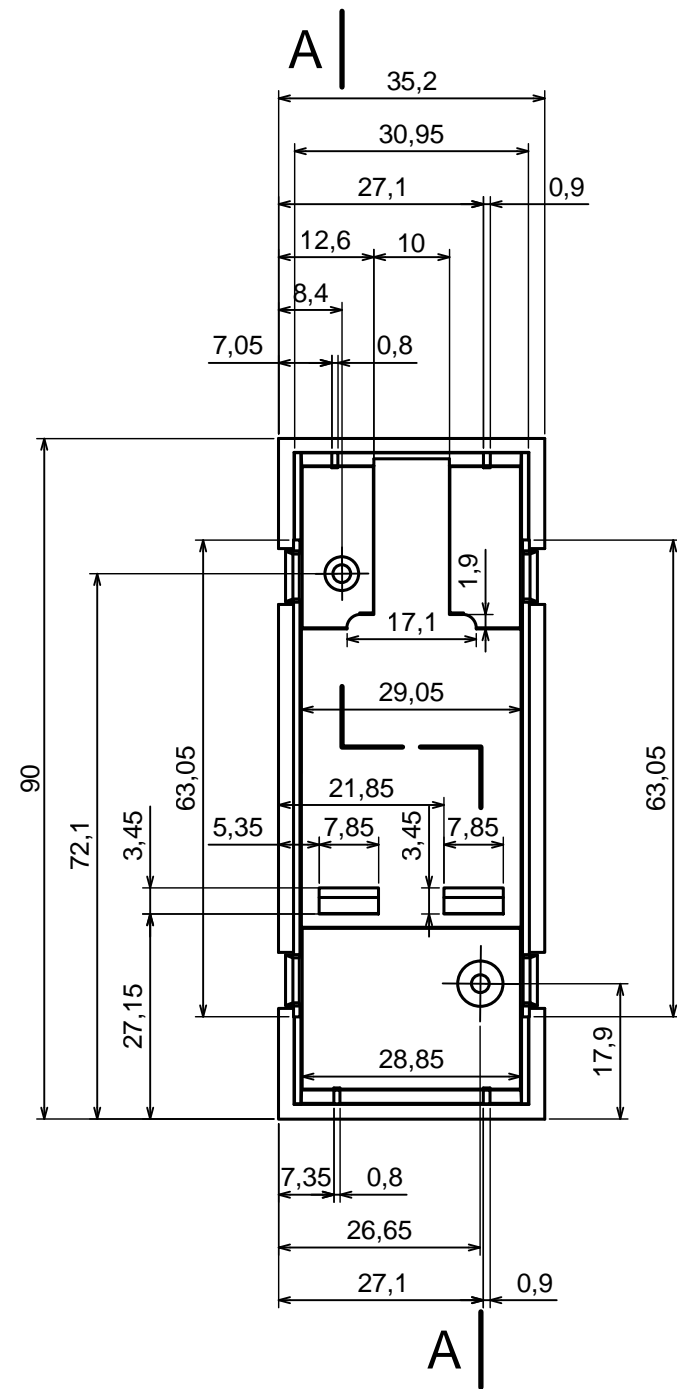

All rights reserved, Copyright Kradox 2016

Product model Enclosure Z106 - base

Format: A3 Material: PS, ABS

Scale 1:1 Tolerance: +/- 0.5



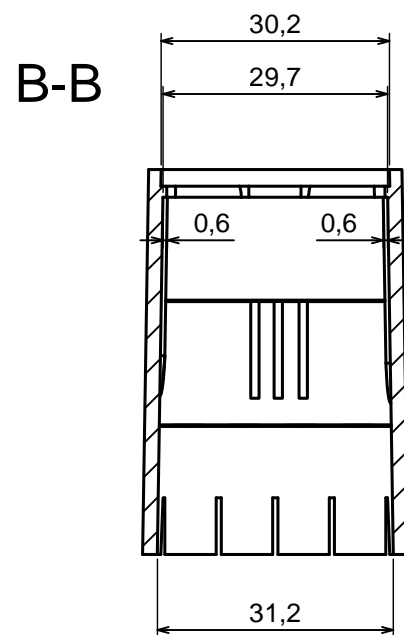
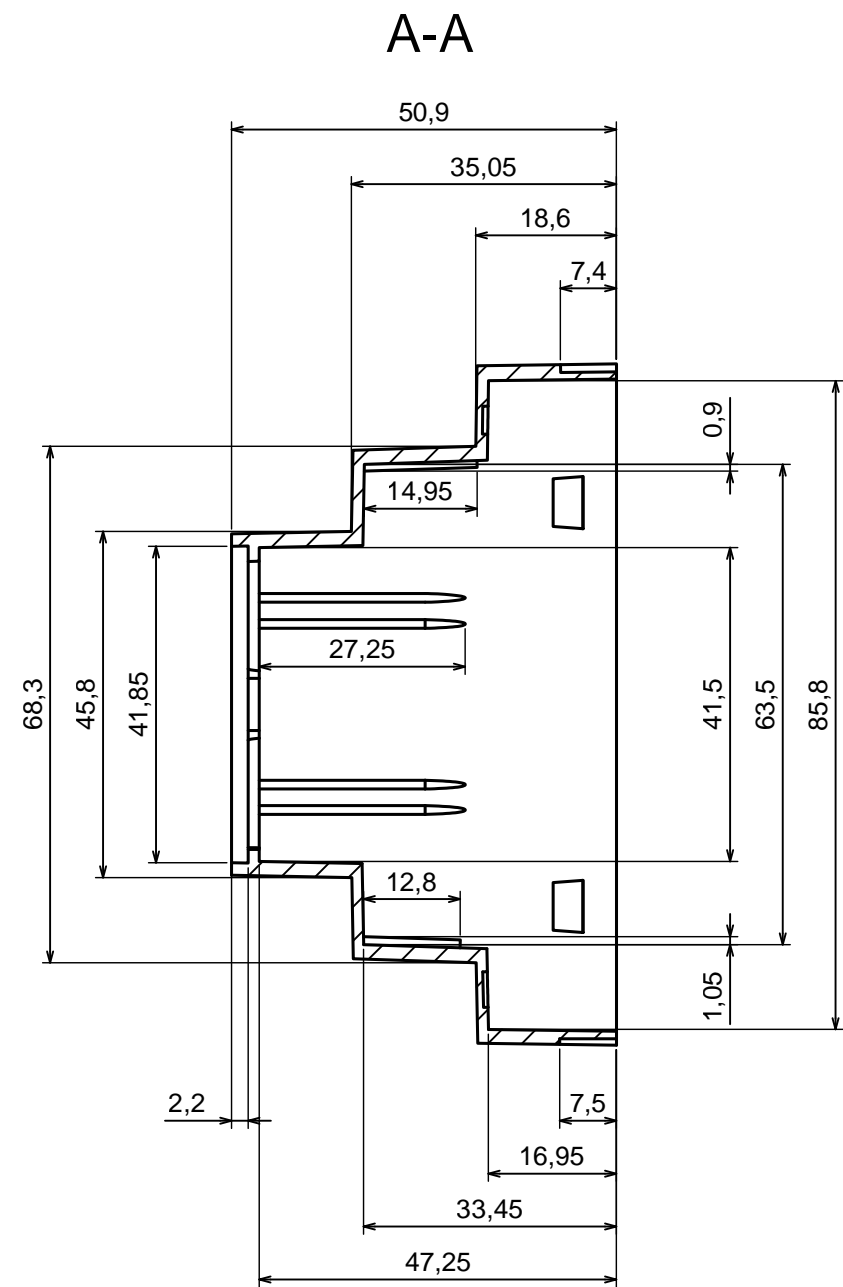
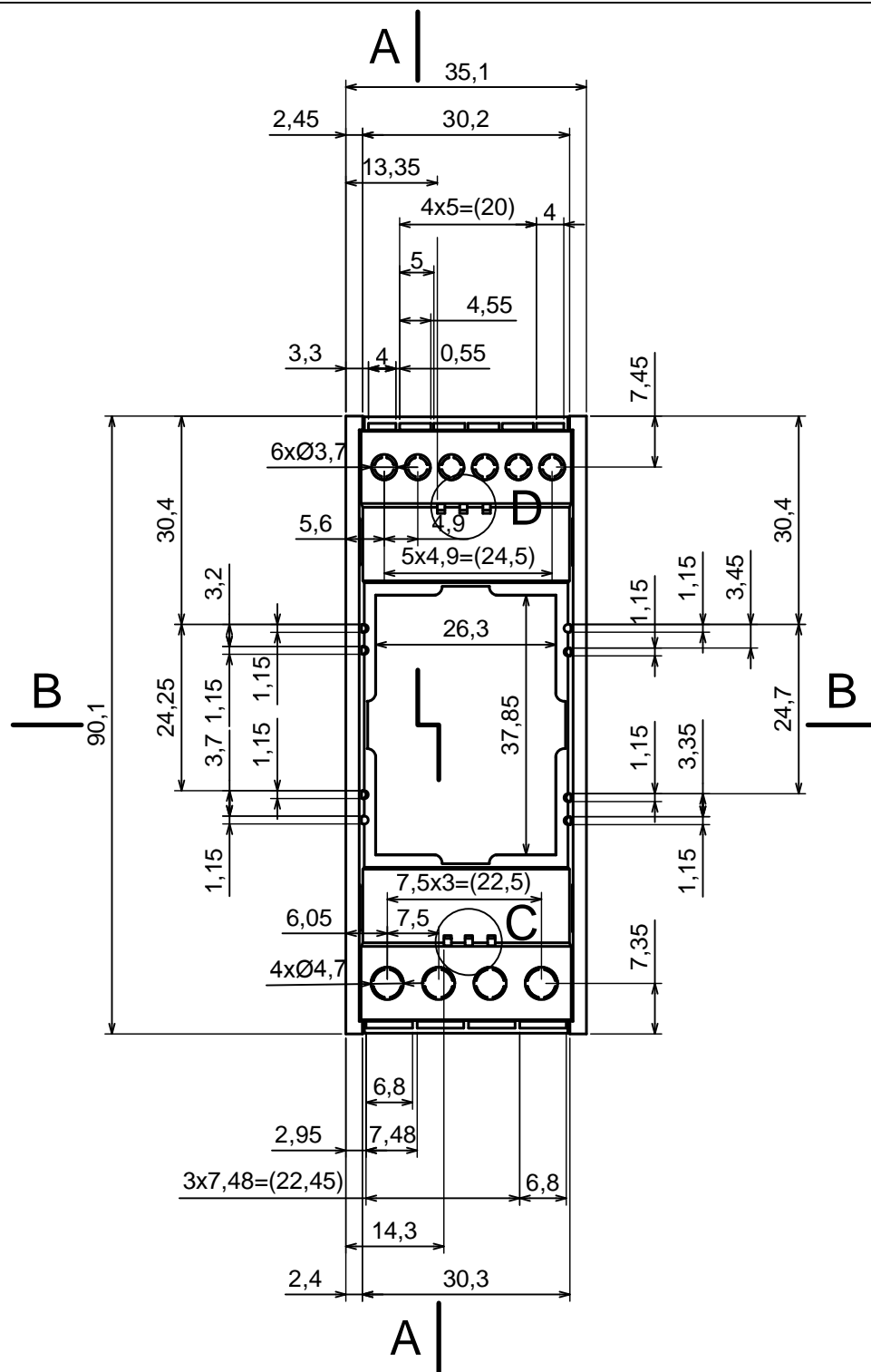
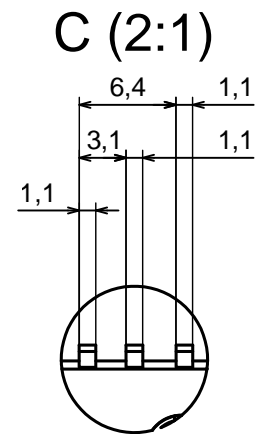
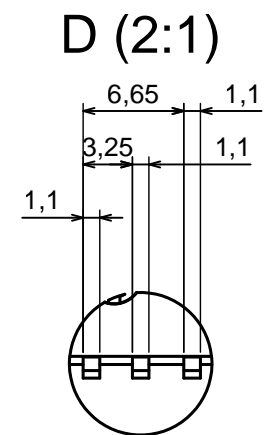

All rights reserved, Copyright Kradox 2016

Product model Enclosure Z106 - cover

Format: A3 Material: PS, ABS

Scale 1:1 Tolerance: +/- 0.5



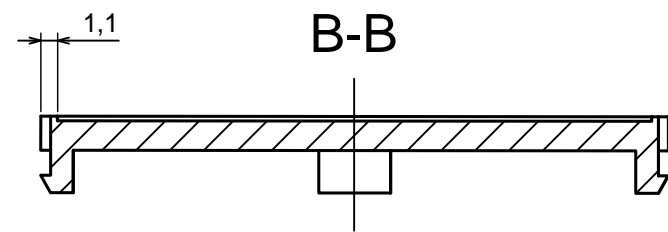
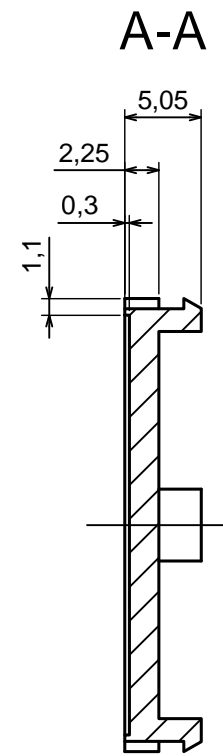
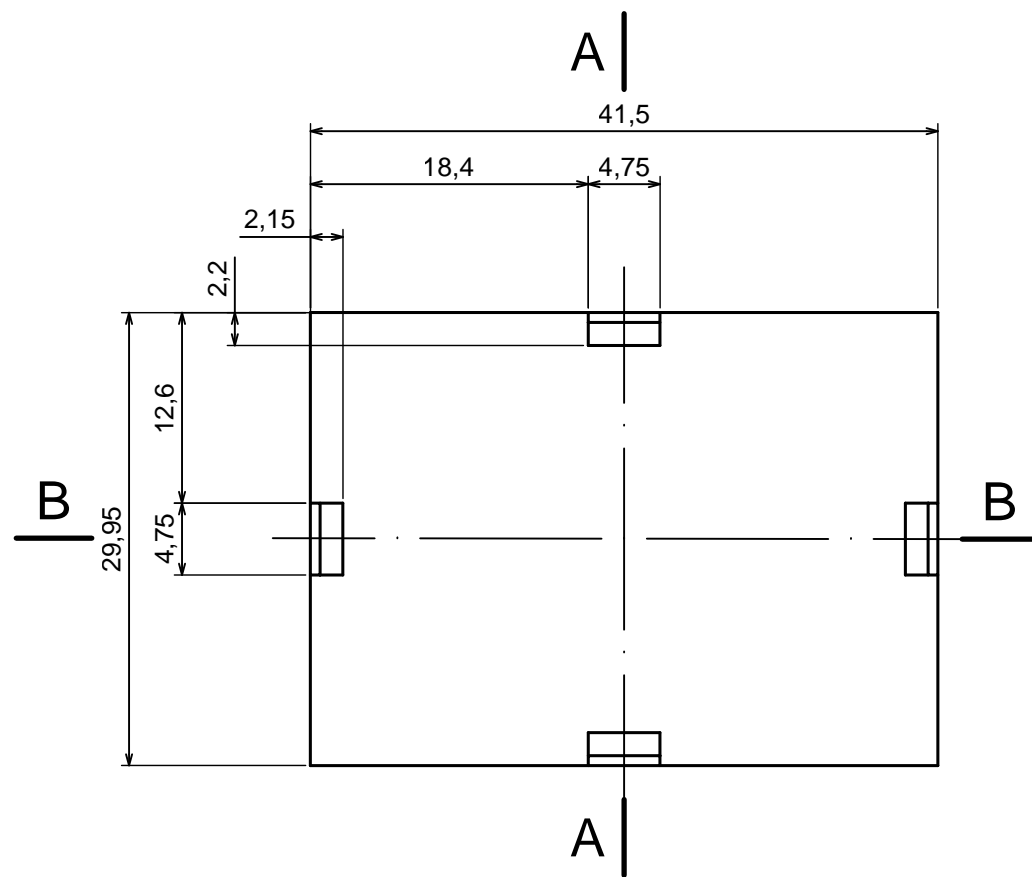

All rights reserved, Copyright Kradox 2016

Product model Enclosure Z106 - filter

Format: A3 Material: PS, ABS

Scale 2:1 Tolerance: +/- 0.5



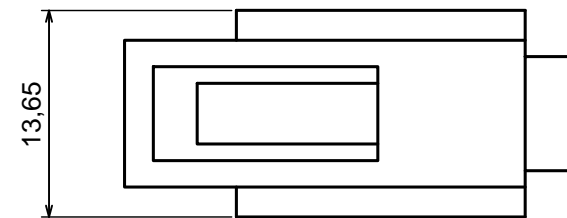
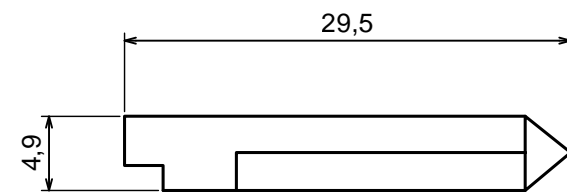

All rights reserved, Copyright Kradex 2016		
Product model	Enclosure Z106 - hook	
Format: A3	Material: PS, ABS	
Scale 2:1	Tolerance: +/- 0.5	